



# Installation Instructions

## XRC Bumper (Part # SB77807)

### 2018 and Up Jeep JL/JT 4dr Front Bumper

**NOTE: Carefully read entire instructions thoroughly before attempting to install this part.**

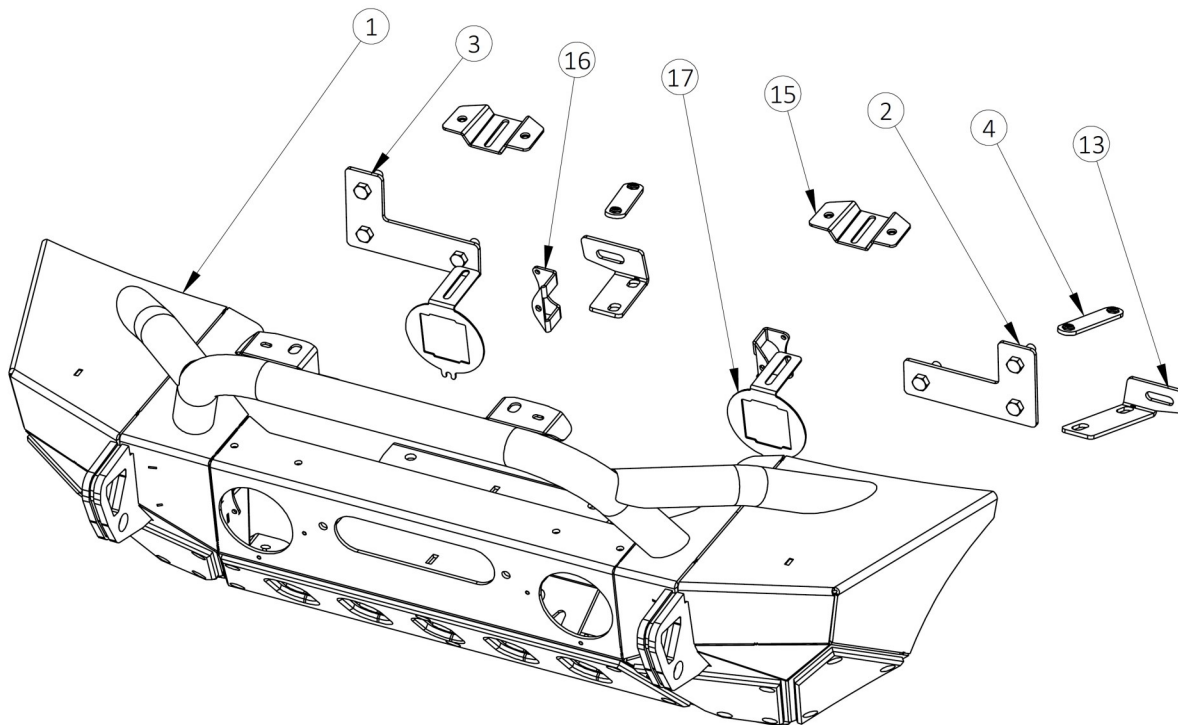

SB77807 Parts Included	QTY	BOM I.D.	SB77807 Parts Included	QTY	BOM I.D.
84-401RM002 XRC Front Bumper	1	1	90-401RM002-02 Hardware Pack	1	
84-401RM004 Bolt Plate: Drvr	1	2	10mm-1.5 X 25mm Hex Head Bolt	2	
84-401RM005 Bolt Plate: Pass	1	3	10mm Flat Washer	4	
84-401RM006 Lower Frame Nut Plate	2	4	10mm-1.5 Nylock Nut	2	
84-401RM008 Lower Frame Mounting Tab: Drvr	1	13	90-401RM002-03 Hardware Pack	1	
84-401RM009 Lower Frame Mounting Tab: Pass	1	14	12mm Flat Washer	6	
84-401RM007 S4 Light Bracket	2	15	12mm-1.5 Nylock Nut	6	
84-401RM010 JK/JL LED Fog Light Adapter	2	16	90-401RM002-04 Hardware Pack	1	
84-401RM012 S4 Light Cover	2	17	5mm-0.8 X 8mm Hex Head Bolt Gr. 8.8	2	
90-401RM002-06 Hardware Pack	1		5mm Flat Washer	4	
8mm-1.25 X 20mm Hex Bolt Gr. 8.8	2		5mm-0.8 Nylock Nut	2	
90-401RM002-01 Hardware Pack	1		90-401RM002-05 Hardware Pack	1	
8mm-1.25 X 20mm Button Head Bolt	4		4mm-0.7 X 16mm Black Button Head Bolt Gr. 8.8	8	
8mm-1.25 X 25mm Flat Head Screw	30		4mm Flat Washer	16	
8mm-1.25 X 30mm Flat Head Screw	4		4mm-0.7 Nylock Nut	8	

**For Technical Support/Warranty Information please call 310-762-9944**



# Installation Instructions

*XRC Bumper (Part # SB77807)*  
*2018 and Up Jeep JL/JT 4dr Front Bumper*

**Step 1:** Park the vehicle on a flat level surface. Apply the parking brake and chock all (4) wheels.

**NOTE:** Installation performed on Jeep Sahara and Jeep Rubicon will be similar.

**Step 2:** Remove the (2) OE bolts and (8) OE plastic push rivets securing the plastic skid plate to the OE metal skid plate. (Fig. A-1 & A-2)

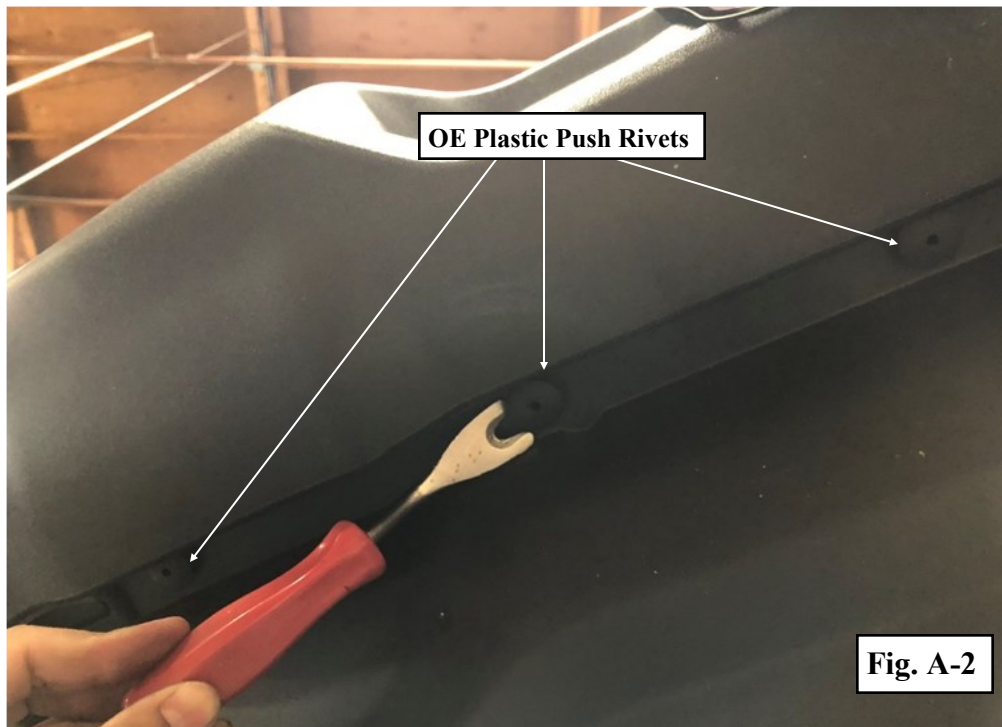
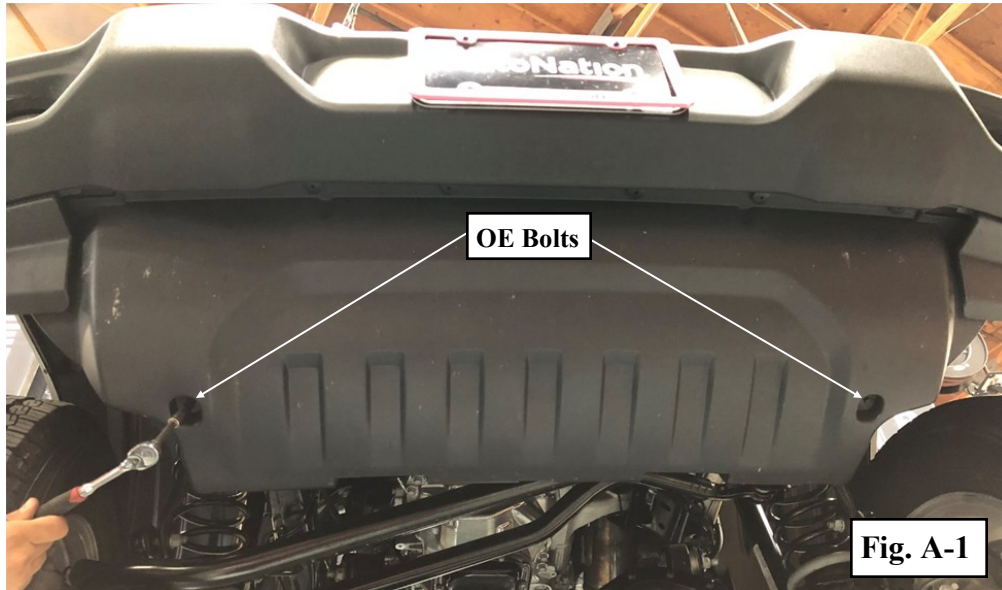

For Technical Support/Warranty Information please call 310-762-9944



# Installation Instructions

*XRC Bumper (Part # SB77807)*  
*2018 and Up Jeep JL/JT 4dr Front Bumper*

**Step 3:** Depress locking tab and disconnect the **OE** fog light wire harness connector located on the passenger side of the vehicle. **(Fig. B)**

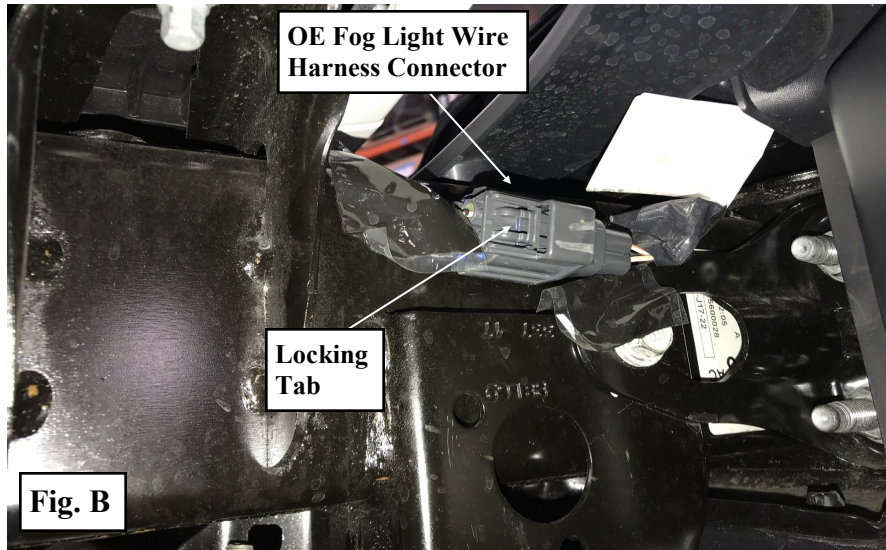

**Step 4:** Remove the (4 Per Side) OE nuts securing the **OE** front bumper to the frame. **(Fig. C)**

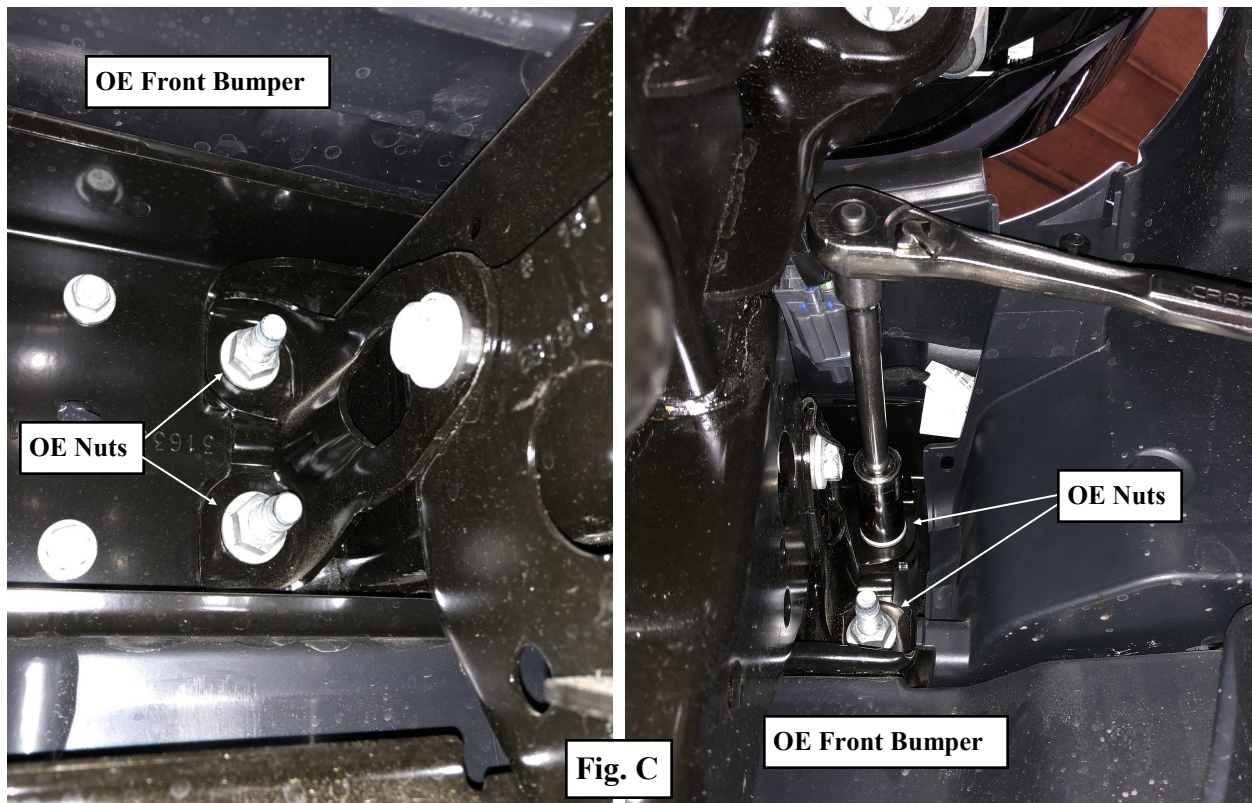

For Technical Support/Warranty Information please call 310-762-9944



# Installation Instructions

*XRC Bumper (Part # SB77807)*  
*2018 and Up Jeep JL/JT 4dr Front Bumper*

**Step 5:** Remove the upper bumper plastic trim by removing (2) OE push pins. (Fig. D)



**Step 6:** Carefully remove the OE front bumper from the vehicle.

**Step 7:** Remove the (2) OE bolts securing the OE metal skid plate and remove the metal skid plate from the frame rails. Save OE hardware for reinstallation. (Fig. E)

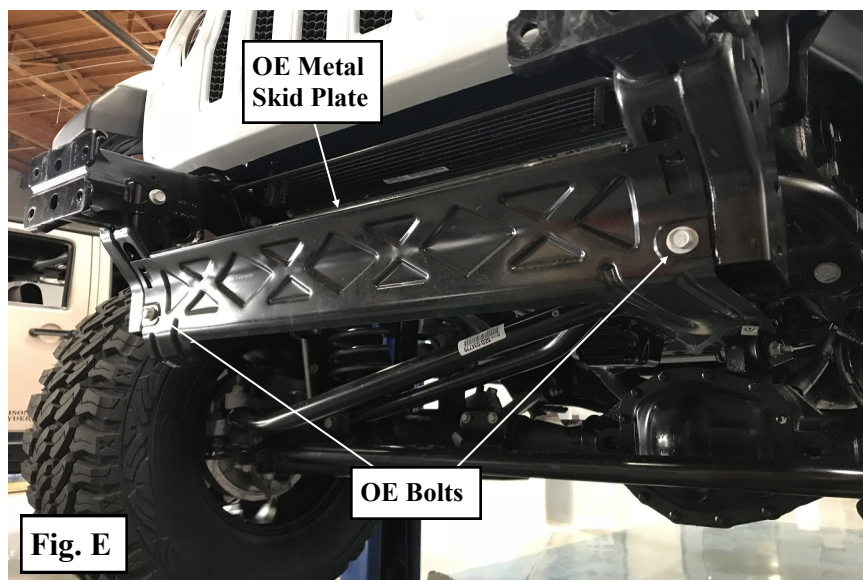

For Technical Support/Warranty Information please call 310-762-9944



# Installation Instructions

*XRC Bumper (Part # SB77807)*  
*2018 and Up Jeep JL/JT 4dr Front Bumper*

**NOTE:** If reinstalling the OE LED lights or OE sport fog, lights perform steps 8 through 12.

**Step 8:** Using a 7mm socket, remove the (6 Per Side) OE screws securing the OE back panels to the OE front bumper. (Fig. F)

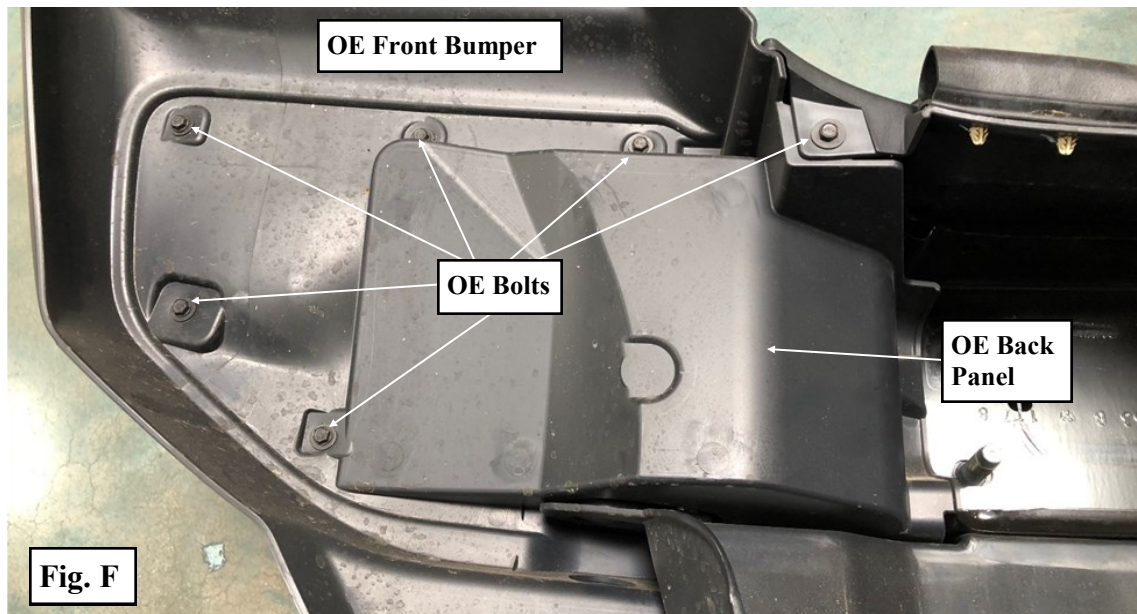

**Step 9:** Remove the (1 per side) OE plastic push rivet. Using a 7mm socket, remove the (1 Per Side) remaining OE screw securing the OE back panels to the OE front bumper. Remove the OE back panel from the OE front bumper. (Fig. G)

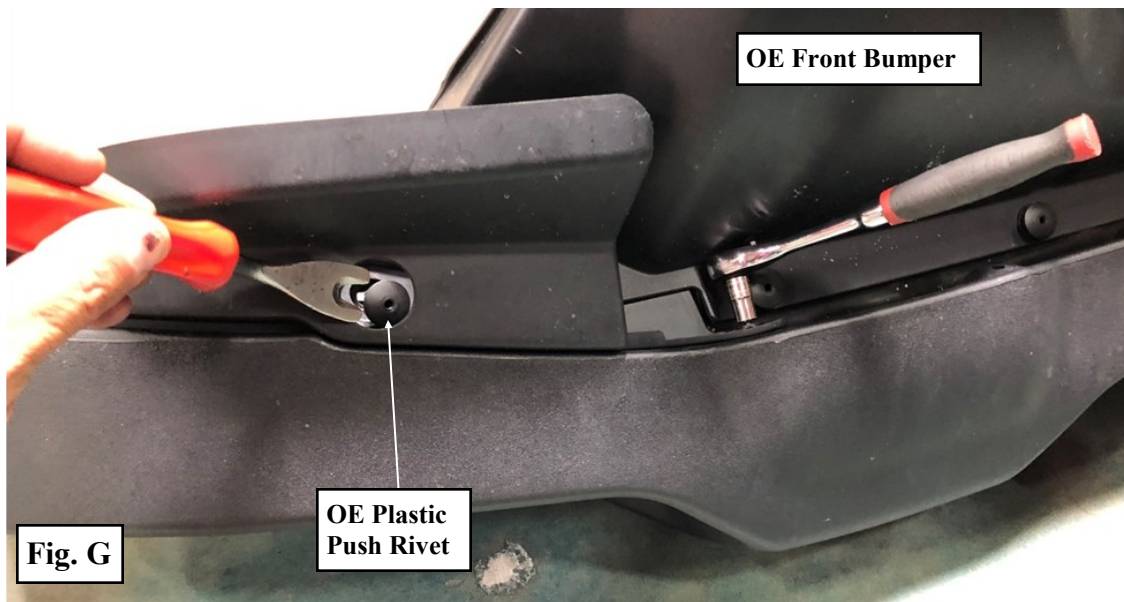

For Technical Support/Warranty Information please call 310-762-9944



# Installation Instructions

*XRC Bumper (Part # SB77807)*  
*2018 and Up Jeep JL/JT 4dr Front Bumper*

**Step 10:** Unbolt the (2 Per Side) OE bolts securing the metal cover to the OE front bumper and remove the OE light wiring harness. (Fig. H)

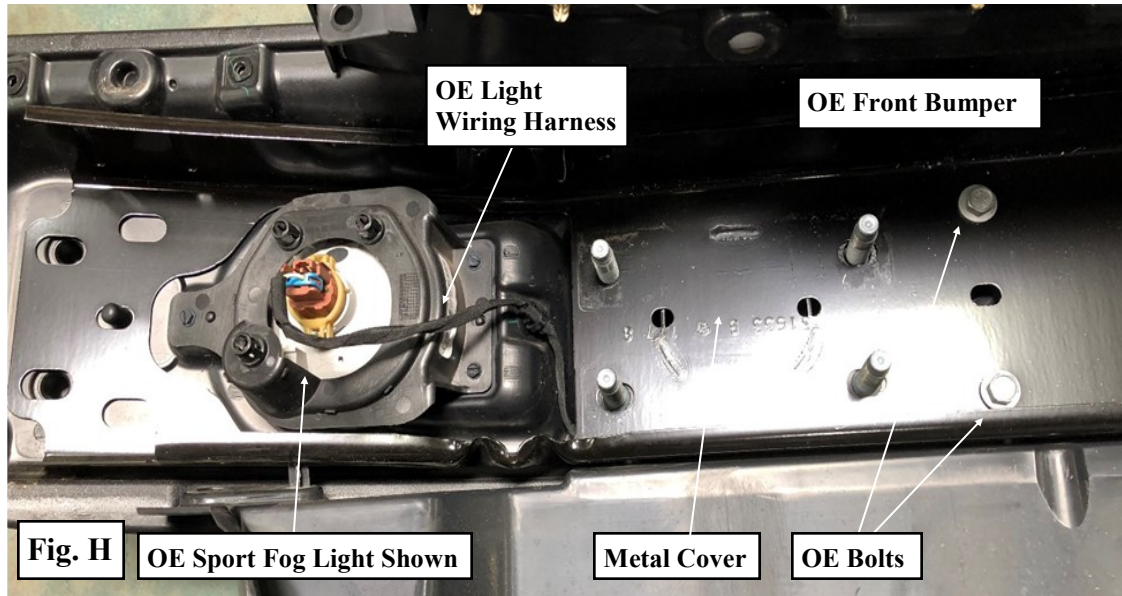

**Step 11:** Depress the locking tab and disconnect the connectors from the OE LED lights or OE sport fog lights. Save the OE wiring harness for reinstallation. (Fig. H)

**Step 12:** Remove the OE retaining screws securing the OE LED lights or OE sport fog lights to the OE front bumper and remove the OE lights from the vehicle. (Fig. H)

**Step 13:** Install the driver and passenger side bolt plates (84-401RM004 drvr and 84-401RM005 pass) to the new front bumper (84-401RM002 XRC) pockets and secure in place using the 12mm bolt retainers. (Fig. I)

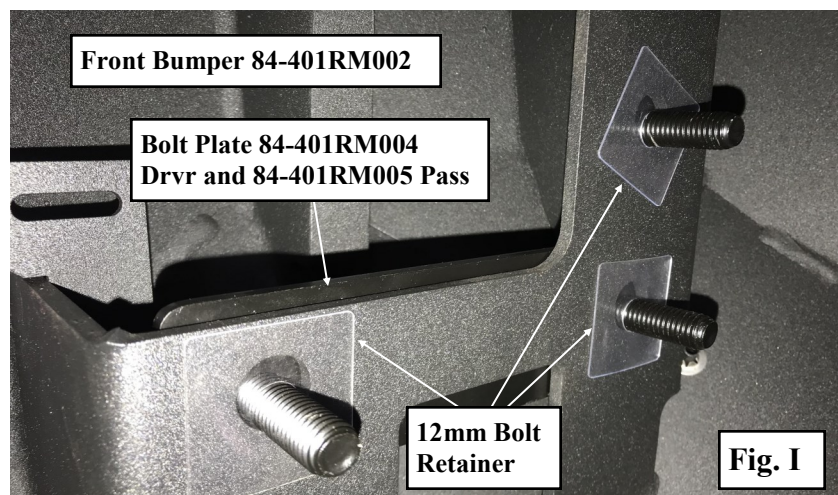

For Technical Support/Warranty Information please call 310-762-9944



# Installation Instructions

*XRC Bumper (Part # SB77807)  
2018 and Up Jeep JL/JT 4dr Front Bumper*

**NOTE:** If reinstalling the OE LED lights, perform steps 14 and 15.

**Step 14:** Install the provided JK/JL fog light adapter (84-401RM010) to the front bumper (84-401RM002 XRC) mounting stud and secure using the (1 Per Light) 5mm nylock nut and washer. (Fig. J)

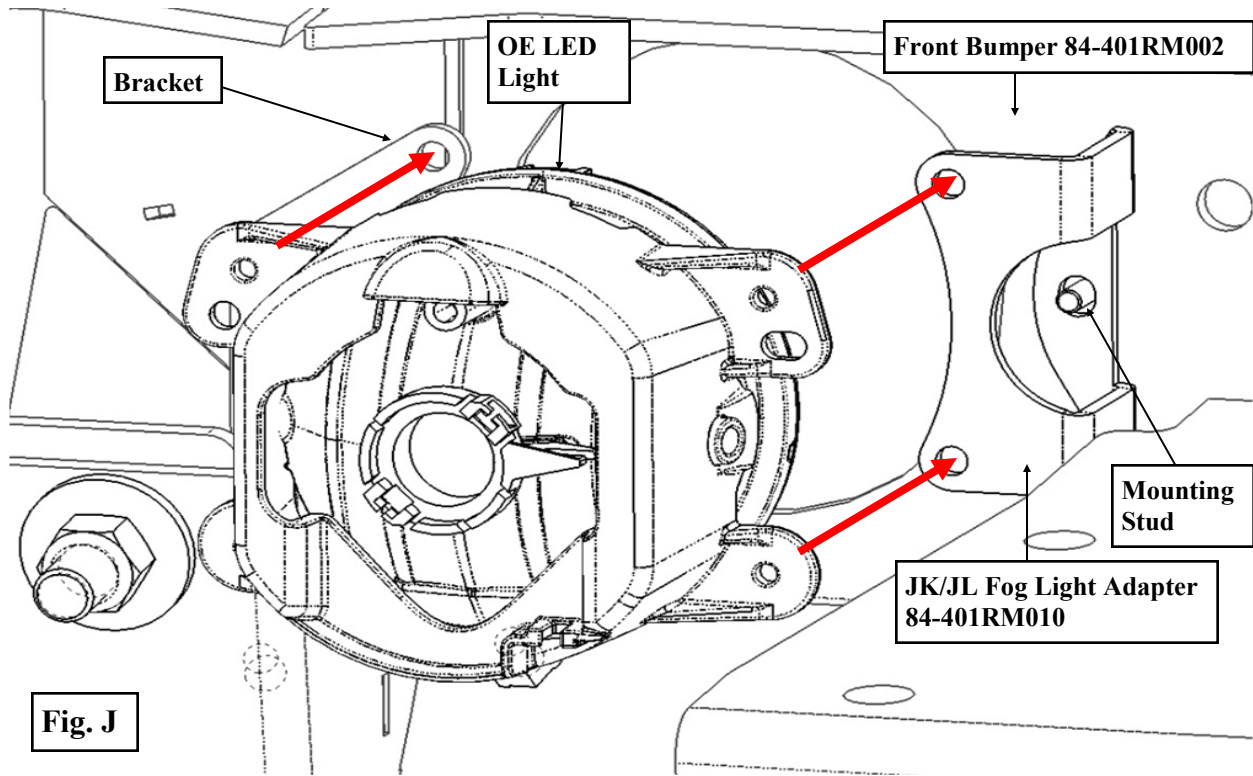

**Step 15:** Secure the OE LED lights to the JK/JL fog light adapter (84-401RM010) and the front bumper (84-401RM002 XRC) bracket using the (4 Per Light) provided 4mm X 16mm bolts and hardware. Make sure the OE LED light are centered in the window and tighten the mounting hardware. (Fig. J)

For Technical Support/Warranty Information please call 310-762-9944

Smittybilt, 400 W Artesia, Compton, CA 90220



# Installation Instructions

## XRC Bumper (Part # SB77807)

### 2018 and Up Jeep JL/JT 4dr Front Bumper

**NOTE:** If reinstalling the OE sport fog lights, perform step 16.

**Step 16:** Secure the OE sport fog lights to the front bumper (84-401RM002 XRC) mounting stud using the (1 Per Light) 5mm nylock nut and flat washer and mounting bracket using the provided (1 Per Light) 5mm X 8mm and hardware. Make sure the OE sport fog lights pods are centered in the window and tighten the mounting hardware. (Fig. K)

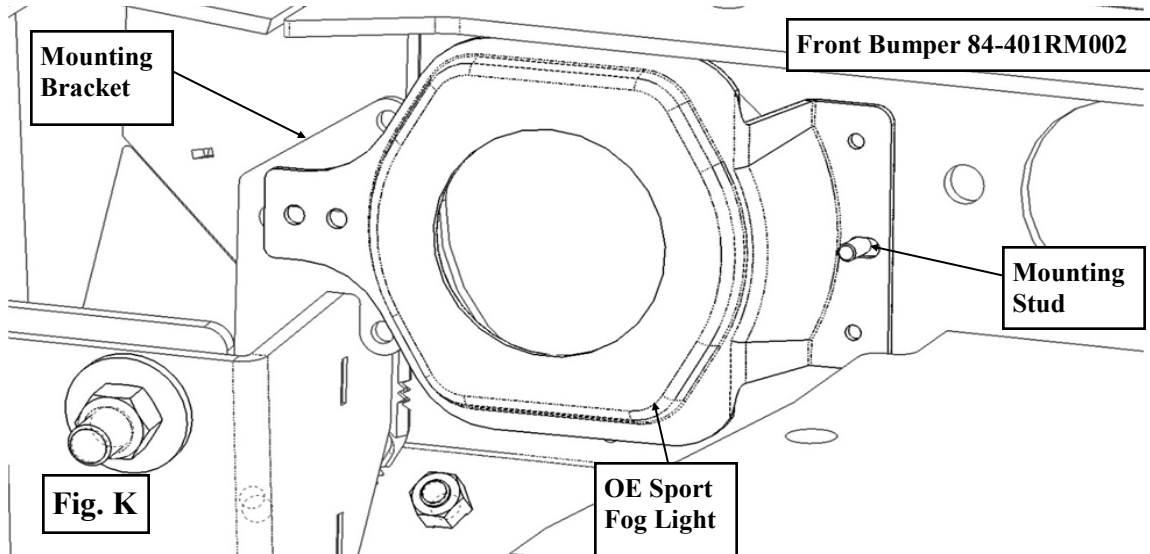

**NOTE:** If installing the S4 style LED light pods perform steps 17 and 18.  
S4 style LED light pods (sold separately).

**Step 17:** Install the provided S4 light brackets (84-401RM007) to the S4 LED light pods using the provided (1 Per Light) 8mm X 20mm button head bolts and hardware. (Fig.

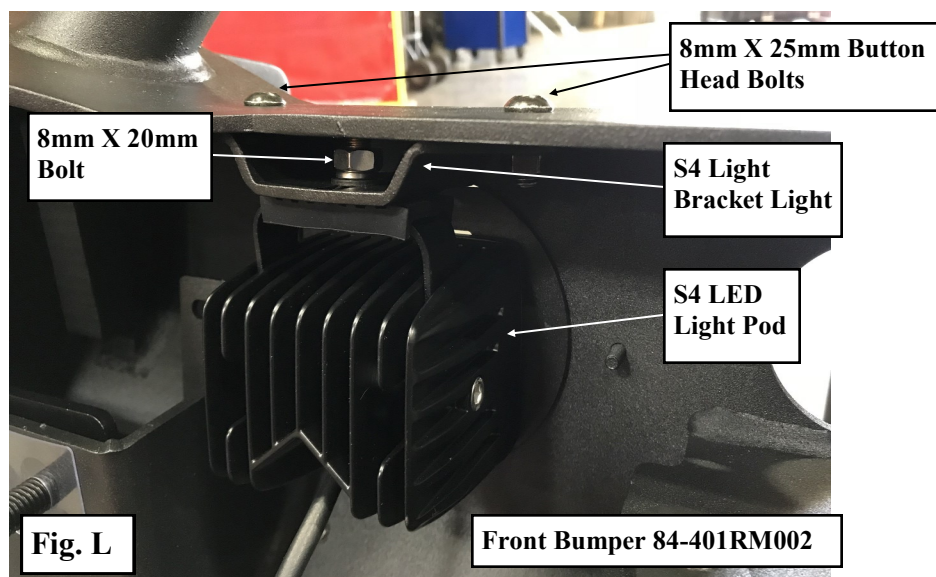

For Technical Support/Warranty Information please call 310-762-9944





# Installation Instructions

## XRC Bumper (Part # SB77807)

### 2018 and Up Jeep JL/JT 4dr Front Bumper

L)

**Step 18:** Install the S4 LED light pods and S4 light bracket (84-401RM007) to the front bumper (84-401RM002 XRC) using the provided (2 Per Light) 8mm X 25mm button head bolts and hardware. Make sure the S4 LED light pods are centered in the window and tighten the mounting hardware. (Fig. L)

**Step 19:** *NOTE: This step might require 2 people.* Raise the new front bumper (84-401RM002 XRC) up into place and align the (3 Per Side) mounting studs on the front bumper with (3 Per Side) holes in the frame mounting plates. Secure using the supplied (3

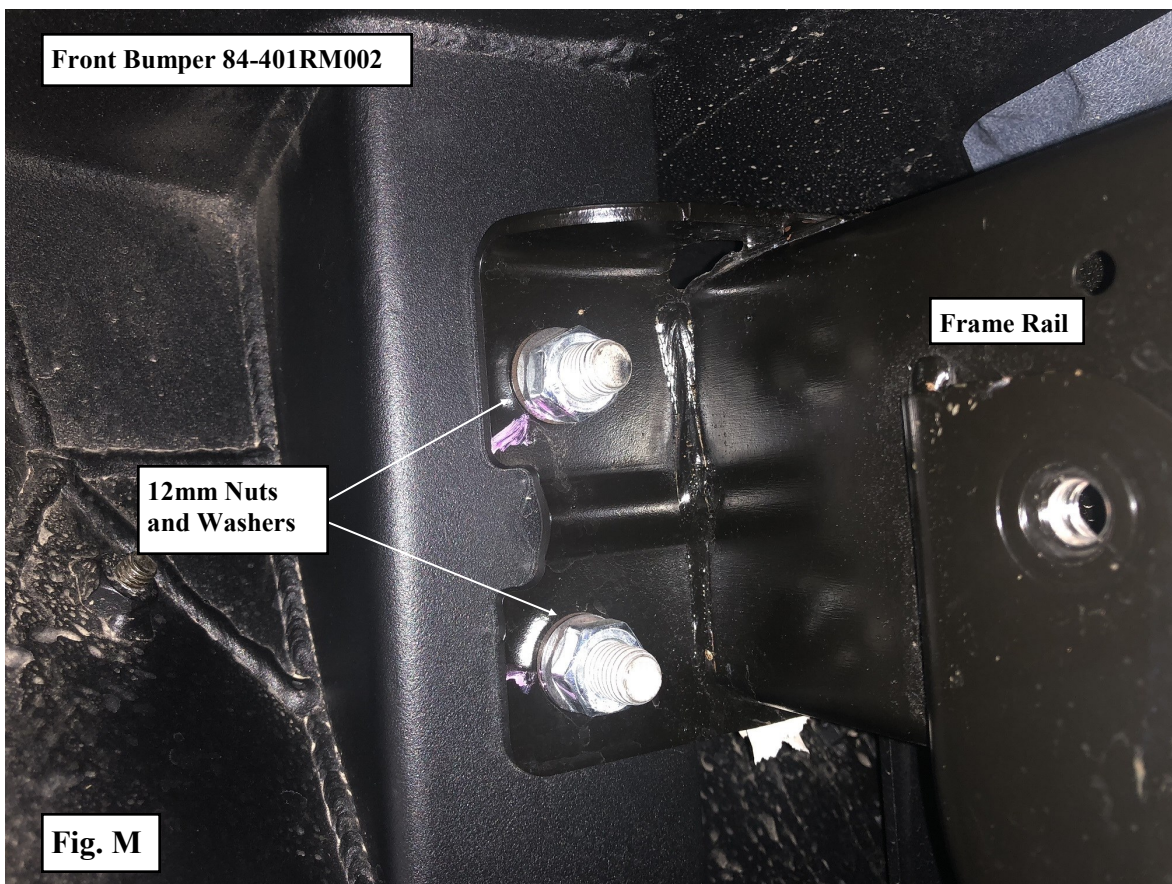

(3 Per Side) 12mm nuts and washers. (Fig. M)

**Step 20:** Install the lower mounting tabs (84-401RM008 drv and 84-401RM009 pass) to the OE metal skid plate mounting holes on frame horns using the (1 Per Side) previously removed 10mm OE bolts. (Fig. N)

*NOTE: If vehicle did not come equipped with OE hardware in lower bumper mounts use the provided (1 Per Side) 10mm X 25mm bolts and hardware.*

For Technical Support/Warranty Information please call 310-762-9944



# Installation Instructions

*XRC Bumper (Part # SB77807)*  
*2018 and Up Jeep JL/JT 4dr Front Bumper*

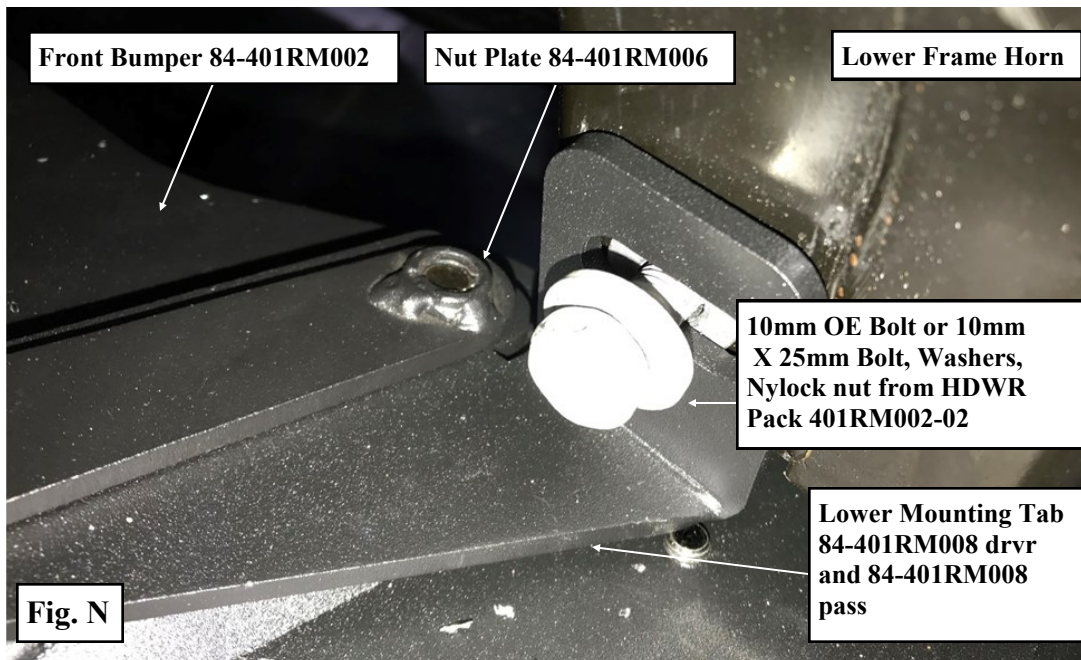

**Step 21:** Secure the (2 Per Side) front bumper lower mounting holes to the lower mounting tabs (84-401RM008 *drv*r and 84-401RM009 *pass*) using the supplied 8mm X 30mm bolts, washers, and nut plates (84-401RM006). (Fig N). If the vehicle does not have an OE Nutsert in the lower frame horn, secure mounting tab with provided M10 hardware in the HDWR pack 401RM002-02.

**Step 22:** Level the front bumper (84-401RM002 XRC) and torque the 12mm hardware to 70 ft./lbs. (Fig M). Torque M10 hardware to 45 ft-lbs.

**Step 23:** If OE fog lights were installed, connect the OE fog light wiring harness.

**Step 24:** If S4 LED light pods were installed, wire the S4 LED light pods per instructions included in the light pod kit.

**IMPORTANT!:** *DO NOT connect S4 LED light pods wiring harnesses until the bumper is fully installed.*

**Step 25:** Installation is now complete. (Fig O)

For Technical Support/Warranty Information please call 310-762-9944

Smittybilt, 400 W Artesia, Compton, CA 90220



# Installation Instructions

*XRC Bumper (Part # SB77807)*  
 2018 and Up Jeep JL/JT 4dr Front Bumper



**Fig. O**

S4 LED Light  
Shown

Finished Installation

OE LED Fog  
Light Shown

Use this only as a guide for hardware without a called out torque specification in the instruction manual.

Bolt Torque and ID							
Decimal System				Metric System			
All Torques in Ft. Lbs. Maximums							
Bolt Size	Grade 5	Grade 8	Bolt Size	Class 9.8	Class 10.9	Class 12.9	
5/16	15	20	M6	5	9	12	
3/8	30	45	M8	18	23	27	
7/16	45	60	M10	32	45	50	
1/2	65	90	M12	55	75	90	
9/16	95	130	M14	85	120	145	
5/8	135	175	M16	130	165	210	
3/4	185	280	M18	170	240	290	

<p>1/2-13x1.75 HHCS</p> <p>D T L X</p>	<p>Grade 5    Grade 8</p> <p>(No. of Marks + 2)</p>	<p>M12-1.25x50 HHCS</p> <p>D T L X</p>
--	---	--

<p>G = Grade (Bolt Strength)</p> <p>D = Nominal Diameter (Inches)</p> <p>T = Thread Count (Threads per Inch)</p> <p>L = Length (Inches)</p> <p>X = Description (Hex Head Cap Screw)</p>	<p>P = Property Class (Bolt Strength)</p> <p>D = Nominal Diameter (Millimeters)</p> <p>T = Thread Pitch (Thread Width, mm)</p> <p>L = Length (Millimeters)</p> <p>X = Description (Hex Head Cap Screw)</p>
---	--

**For Technical Support/Warranty Information please call 310-762-9944**



# Installation Instructions

## *XRC Bumper (Part # SB77807)*

### *2018 and Up Jeep JL/JT 4dr Front Bumper*

#### Product cleaning and maintenance instructions

**Stainless Steel Finish** – Aluminum polish may be used to polish small scratches and scuffs on the finish. Mild soap, window or glass cleaner may be used to clean the finish. **Dual state powder coat finish** – Mild soap, window or glass cleaner may be used to clean the finish. In order to protect the finish, you may wax your product on a regular basis with pure carnauba automotive wax. Do not use any types of soap, polish or was that contains abrasive that could damage the finish. **Textured coated finishes** should be cleaned with a mild soap on a damp sponge. Do not apply polish or was that requires to be removed by means of buffing. This type of wax is commonly used at car wash facilities. **Chrome Finish** – Mild soap, window or glass cleaner may be used to clean the finish. In order to protect the finish you should wax your product on a regular basis with pure carnauba automotive wax. Do not use any types of soap, polish or was that contains abrasive that could damage the finish.

#### Limited Warranties

Smittybilt's products are covered under the following limited warranties only. Note that the duration of the limited warranty differs according to the material and finish of the product purchased. Subject to the duration and conditions of the limited warranty stated below, Smittybilt warrants to the original retail purchaser that its products are free from defects in material and workmanship. All other warranties and representations express or implied, are hereby disclaimed, including fitness for merchantability and buyer's intended use or purpose. All parts are sold "AS IS" except for the limited warranties granted herein. Buyer assumes all risks as to the selection, suitability and performance of all goods and products selected. This limited warranty does not cover damage or impairment in any part due to misuse, improper installation, accident or contact with on-road or off-road hazards, product modification, improper or inadequate cleaning and/or maintenance. Smittybilt is not responsible for items damaged during shipping. This warranty is not transferable from the original buyer. For the original Buyer to be eligible for the limited warranty coverage, the Buyer must provide proof of purchase. Smittybilt strongly recommends returning the warranty registration card.

Customer's remedy hereunder shall be limited only to repair or replacement (at Smittybilt's option) of any defective part(s) returned to Smittybilt at customer's expense. The determination of whether or not a returned part is defective or subject to coverage under the limited warranties stated herein shall be made at Smittybilt's sole discretion.

To assure product quality, Smittybilt reserves the right to change product design, material, specification and finishes without prior notice to customers. This limited warranty gives you specific legal rights and you may also have other rights, which may vary from state to state. Some states do not allow limitations on how long an implied warranty lasts, so the above limitations may not apply as to you. Also, some states do not allow the exclusion or limitation of incidental or consequential damages, so the above limitations or exclusions may not apply to you. Smittybilt reserves the right to discontinue product lines and substitute products, or provide other remedies than those listed in this limited warranty for those discontinued products.

#### Warning

Rollover and other types of vehicle accidents may result in serious injury or death to you, your passengers and others sharing the road. Smittybilt accessories are decorative and are not intended to reduce or avoid injury or damage in the event of an accident. The weight and location of Smittybilt accessories may affect your vehicles' handling, stability and performance, creating an increased risk of accident or rollover. Before installing any accessory, check

**For Technical Support/Warranty Information please call 310-762-9944**

---

**Smittybilt, 400 W Artesia, Compton, CA 90220**